



UPSTATE DOOR

FINE DOOR SOLUTIONS... ONE SOURCE

*Layout 1070.2 Two Panel
(Arched Top/Arched Panel)*

Minimum Width Available is 20" for this Layout

Distinctive Exterior Standard Stiles/Top Rail Are 5-1/2"

*Please View Our Specification Section to View Our Sizing Parameters
for Our Classics Line.*

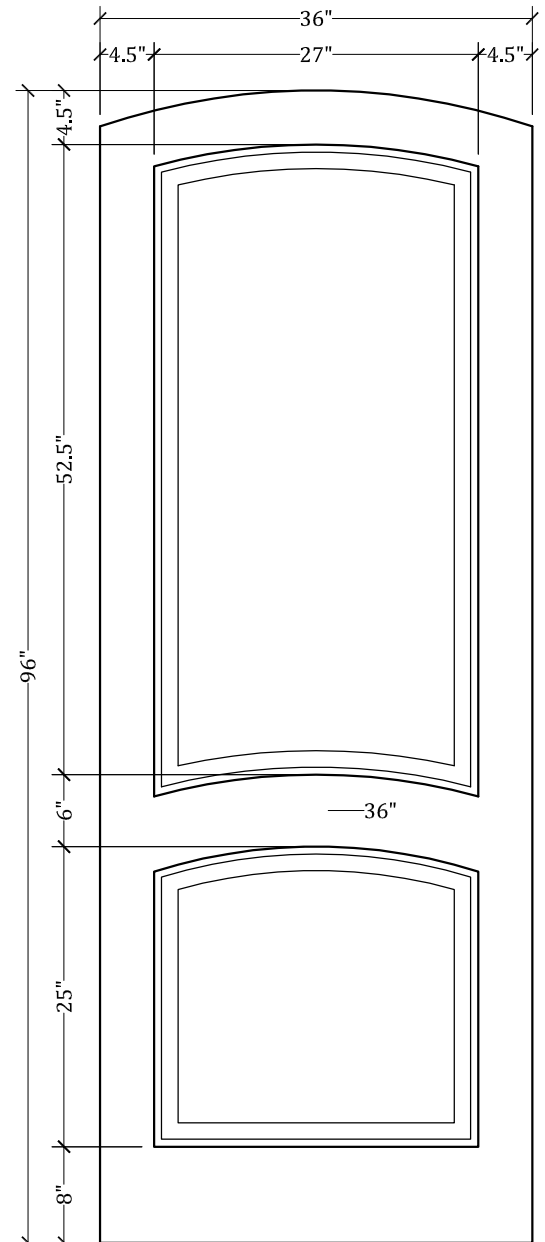
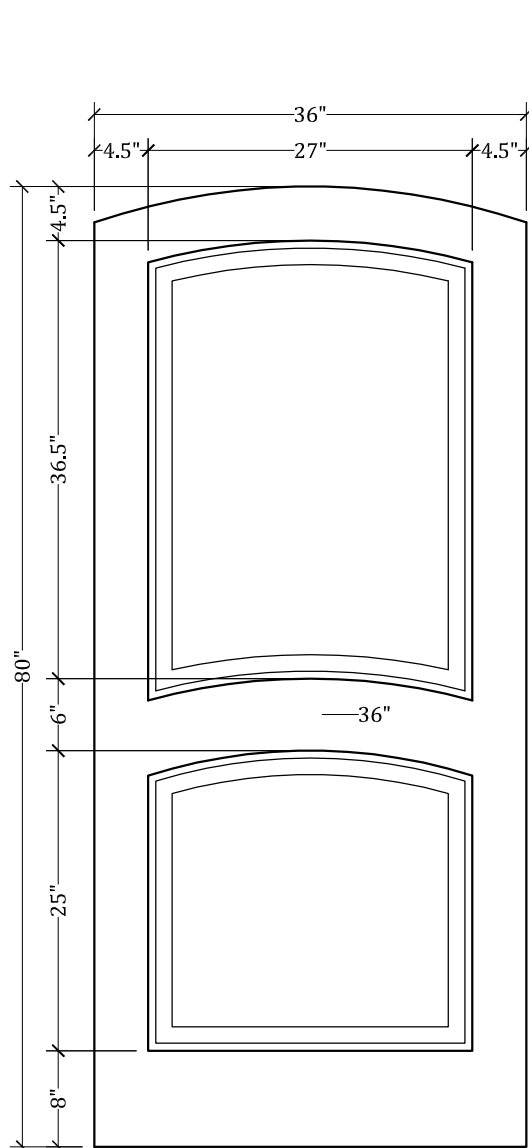

1-800-570-8283

sales@upstatedoor.com

www.upstatedoor.com