



# UPSTATE DOOR

FINE DOOR SOLUTIONS... ONE SOURCE

*Layout 1550.1 Three Panel  
(Square Top/Arched Panel)*

*Minimum Width Available is 24" for this Layout*

*Distinctive Exterior Standard Stiles/Top Rail Are 5-1/2"*

*Please View Our Specification Section to View Our Sizing Parameters  
for Our Classics Line.*

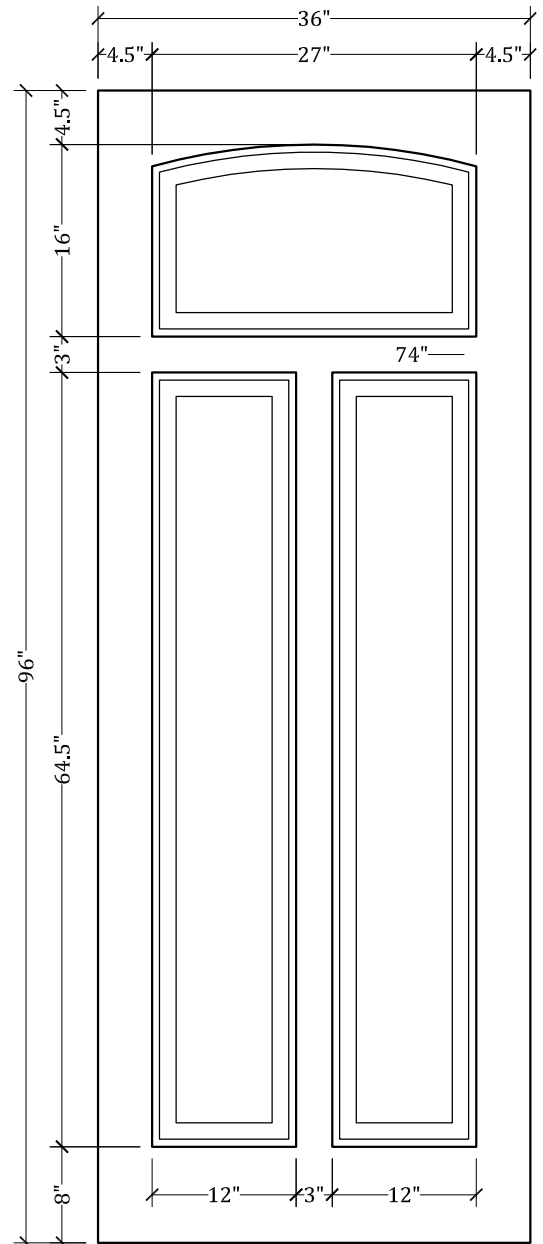
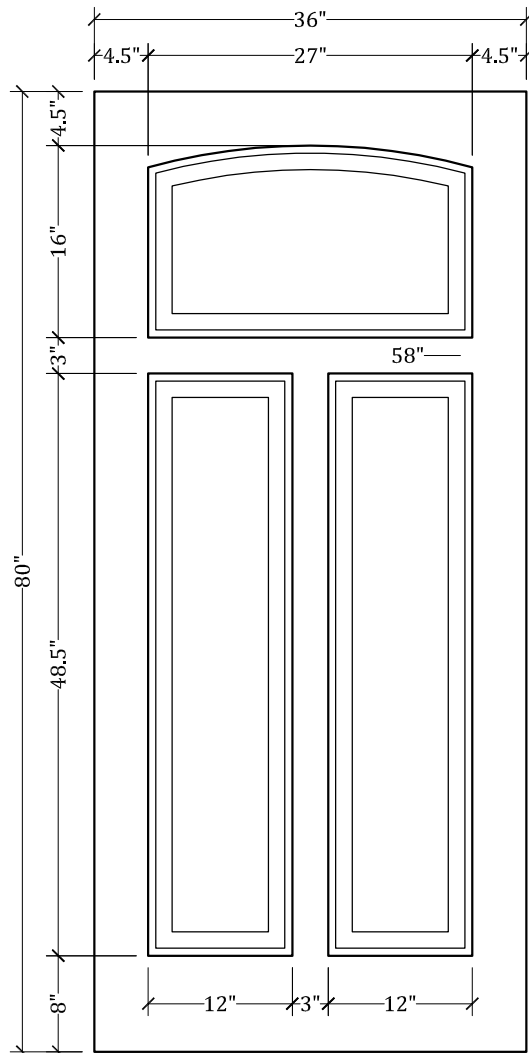

1-800-570-8283

[sales@upstatedoor.com](mailto:sales@upstatedoor.com)

[www.upstatedoor.com](http://www.upstatedoor.com)